



KOMPATTO 221

**TECHNICAL DATA
SPÉCIFICATIONS PRODUIT
ESPECIFICACION TÉCNICA**

KOMPATTO 221

The KOMPATTO 221 Screener is a small yet robust machine designed for recycling, composting, topsoil, landscaping, and contract building industries. Its compact size, quick set-up times, ease of transport and ease of operation makes the KOMPATTO 221 the ideal solution for small scale operations.

La KOMPATTO 221 est une machine petite mais robuste conçue pour les industries du recyclage, du compostage, de la terre végétale, de l'aménagement paysager et de la construction contractuelle. Sa taille compacte, ses temps d'installation rapides, sa facilité de transport et sa facilité d'utilisation font du KOMPATTO 221 la solution idéale pour les opérations à petite échelle.

La KOMPATTO 221 es una criba compacta pero también robusta, diseñada para aplicaciones de reciclaje, compostaje, tierra vegetal, paisajismo y construcción. Su diseño compacto, y su fácil operación y transporte, convierte la criba KOMPATTO 221 en la herramienta ideal para operadores pequeños.

1. SCREEN BOX/CRIBLE/CRIBLA
2. FINE SIZE/TAPIS FINES/CINTA FINO
3. MID-SIZE/GRAIN MOYEN/CINTA MEDIO
4. POWER UNIT/MOTEUR/ACCIONAMIENTO
5. CONTROL/COMMANDE/CONTROL
6. TRACKS/CHENILLES/ORUGA



1



SCREENER



TECHNICAL DATA
SPÉCIFICATIONS PRODUIT
ESPECIFICACION TÉCNICA

SCREEN BOX
CRIBLE CAISSON
CRIBLA

2200X1100mm (10'X4')

OUTPUT POTENTIAL UP TO
PRODUCTION/RENDEMENT JUSQU'A'
PRODUCCION HASTA

80tph / 90 US tph



POWERUNIT

MOTEUR

ACCIONAMIENTO

Stage V: 18,5kW / 25Hp Diesel Engine

Tier 4Final: 18,5kW / 25Hp Diesel Engine

Stage 3A: 21,5kW / 28Hp Diesel Engine

WEIGHT

POIDS

PESO

3.300kgs (7.275lbs)

STANDARD MACHINE

GENERAL MACHINE

STANDARD

Remote control
Radio control
Remoto

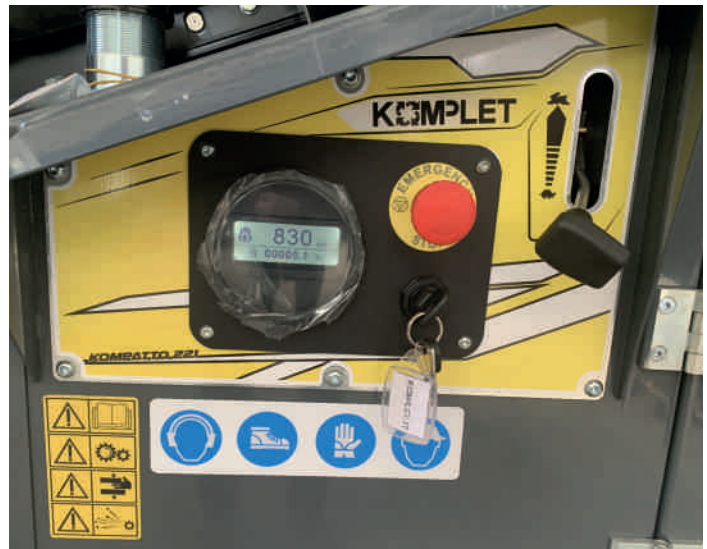

OPTION

Long fine size
Punch plate – Mesh – Mesh Arpa
Longeur tapis fines
Plaque perforée – Mailles – Grille Losange
Largo cinta medio
Planchas perforadas – Mallas – Mallas Arpa

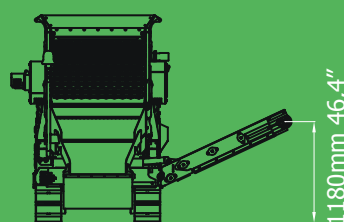
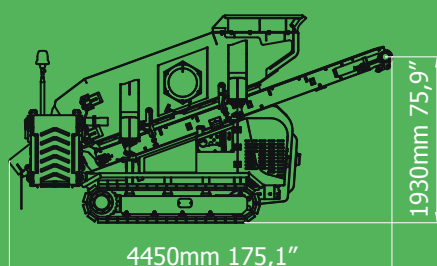
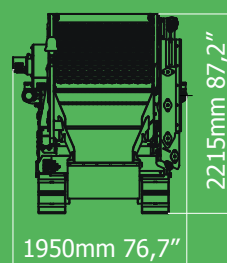
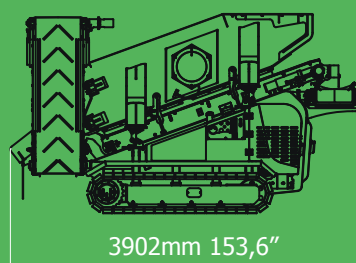
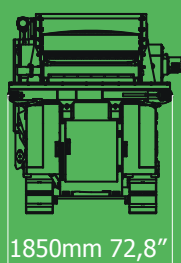
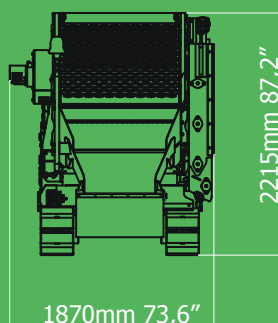
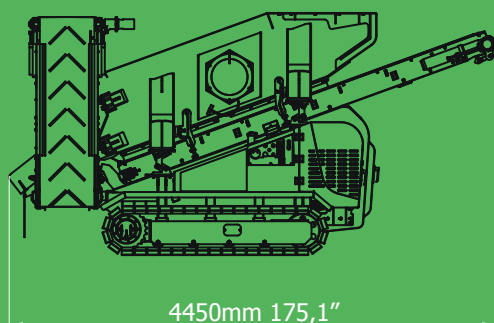

QUICK, EASY AND SAFE TRANSPORT
TRANSPORT RAPIDE, FACILE ET SÛR
TRANSPORTE RÀPIDO, FACIL Y ASEGURADO



DEALER

WWW.KOMPLET.IT
WWW.KOMPLETAMERICA.COM

